

I

DO NOT SCALE THIS PRINT

CONFIDENTIAL AND TRADE SECRET INFORMATION OF NATURAL GAS FUEL SYSTEMS, INC. dba MOMENTUM FUEL TECHNOLOGIES
 This document and the information in it is confidential, proprietary and trade secret information of Natural Gas Fuel Systems, Inc. dba Momentum Fuel Technologies on behalf of itself and its subsidiaries and affiliates ("Momentum"). It contains information intended only for the person to whom it is transmitted and may not be disclosed to any third party, in whole or in part, or used to manufacture anything shown or referred to herein, without Momentum's express, written permission. This document must be returned to Momentum on request.

Any form of reproduction, dissemination, copying, disclosure, modification, distribution, and or publication of this document and the information contained herein is strictly prohibited.

This notice must appear on any complete or partial reproduction of this document or the information contained herein.

Copyright © 2017 Natural Gas Fuel Systems, Inc. dba Momentum Fuel Technologies. All rights reserved.

ALL DIMENSION TOLERANCES UNLESS NOTED
 ONE PLACE .X ±.06
 TWO PLACES .XX ±.03
 THREE PLACES .XXX ±.010
 FOUR PLACES .XXXX ±.0010
 ANGLES ±1.0°
 ALL MACHINED SURFACES TO BE 250 RMS UNLESS NOTED.

NOTES:

- 1) FOR INFORMATION NOT CONTAINED IN THIS PRINT REFERENCE THE MATH DATA FOR THIS PART (602-000060-000000000 WITH STEPS-RH)
- 2) ALL DIMENSIONS ARE IN INCHES
- 3) 60 DGE WITHOUT FMM/FILL
 FULL SYSTEM WEIGHT WITH STEPS AND ALL MOUNTING HARDWARE ON SYSTEM:
 1115 POUNDS WITH STANDARD MOUNTS (ESTIMATED)
 1162 POUNDS WITH 3" RAISED MOUNTS (ESTIMATED)
 WEIGHT OF STAND ALONE FMM (WITH FILL): 64 POUNDS (WITH ELECTRONICS)
 WEIGHT OF FUEL: 380.3 POUNDS

DRAWN	8/26/2017	MOMENTUM FUEL TECHNOLOGIES 1051 Republic Drive, Suite 200 Roanoke, TX 76262	
CHECKED	6/8/2018	TITLE	
CBC		60 DGE SIDE MOUNT - PARTS	
QA		SIZE	DWG NO
MFG		D	602-000060-STEPS-PARTS
APPROVED		SCALE	REV
PART MASS			
N/A			

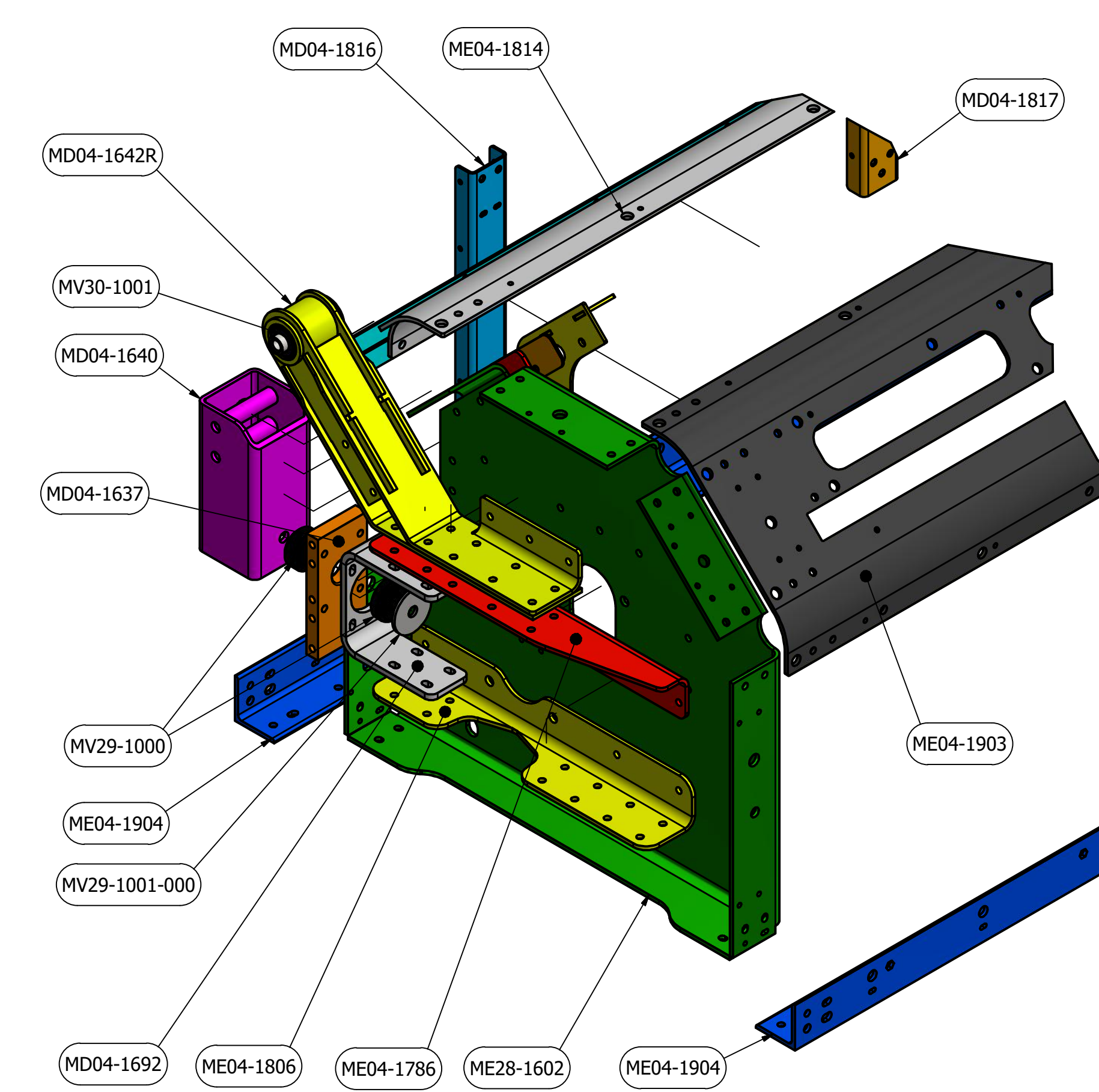
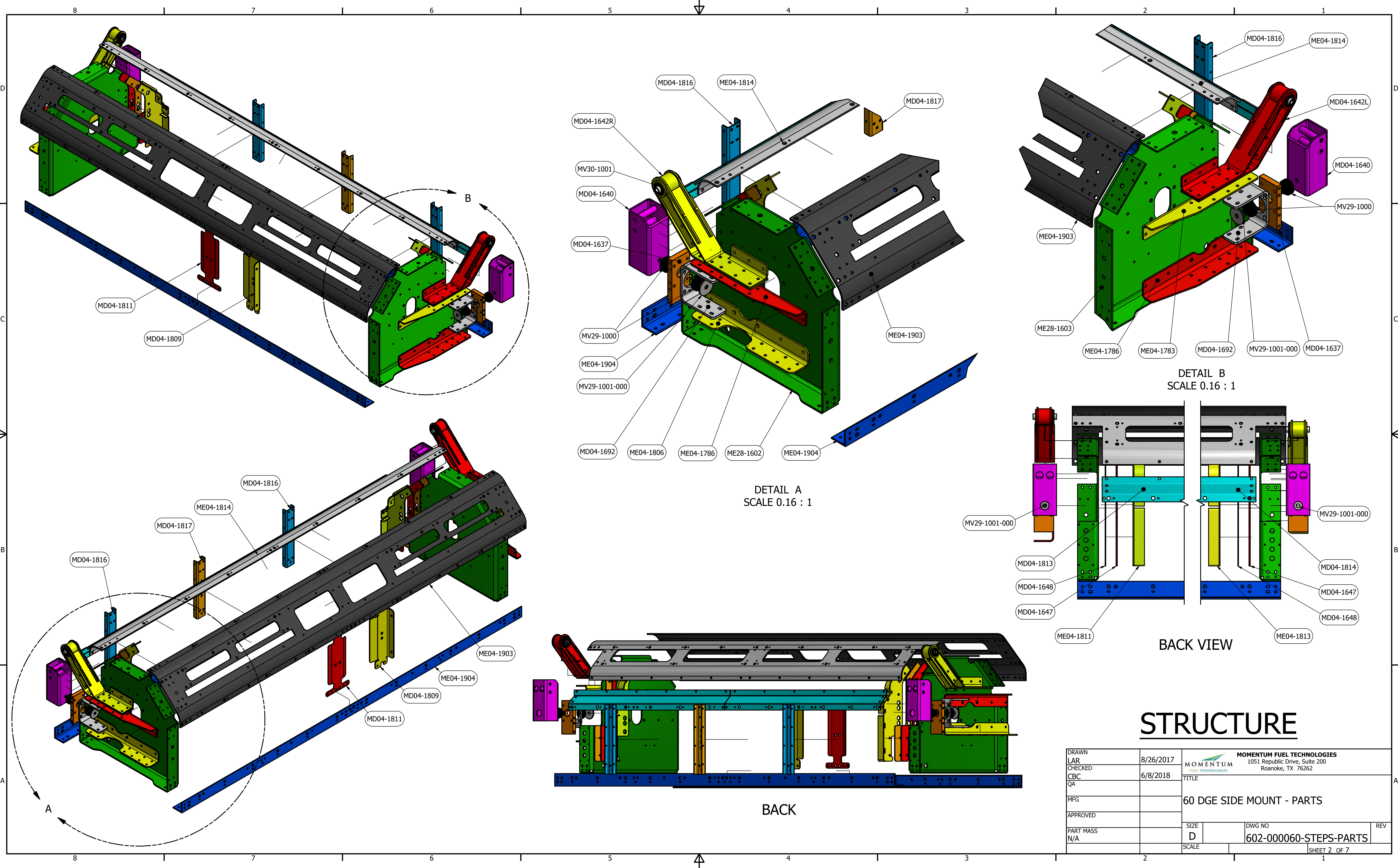

DETAIL A
SCALE 0.16 : 1

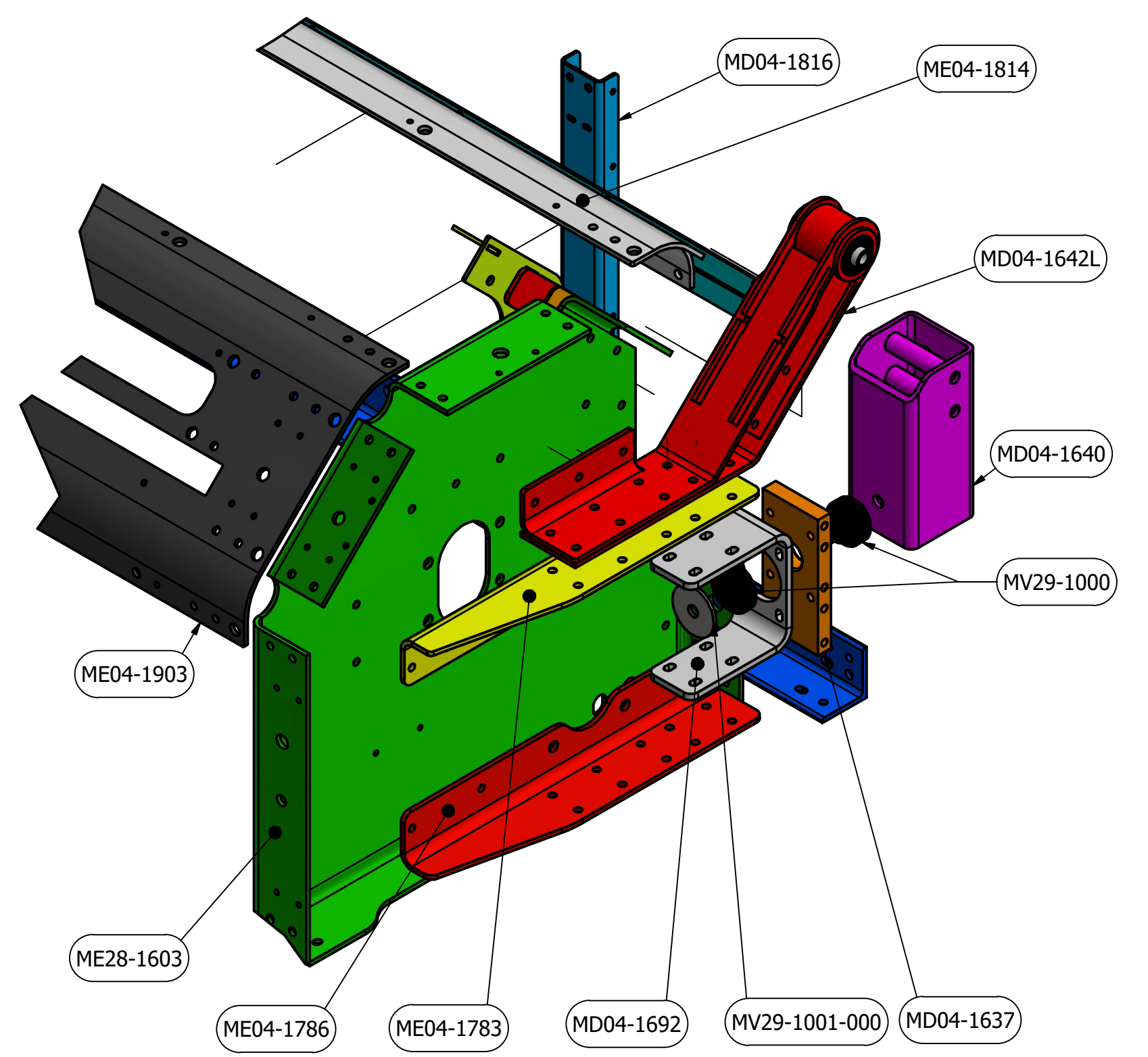

DETAIL B
SCALE 0.16 : 1

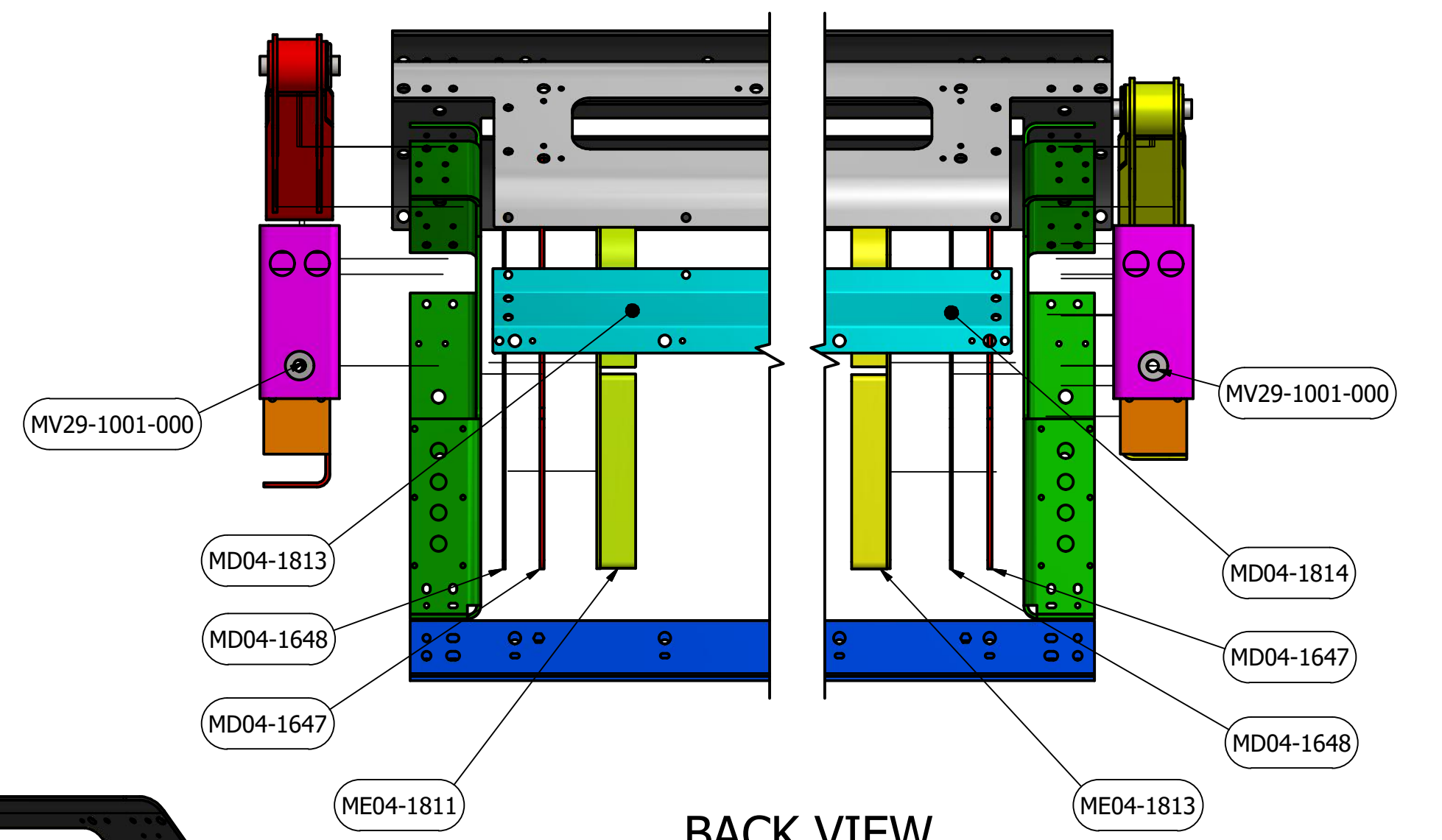

BACK VIEW

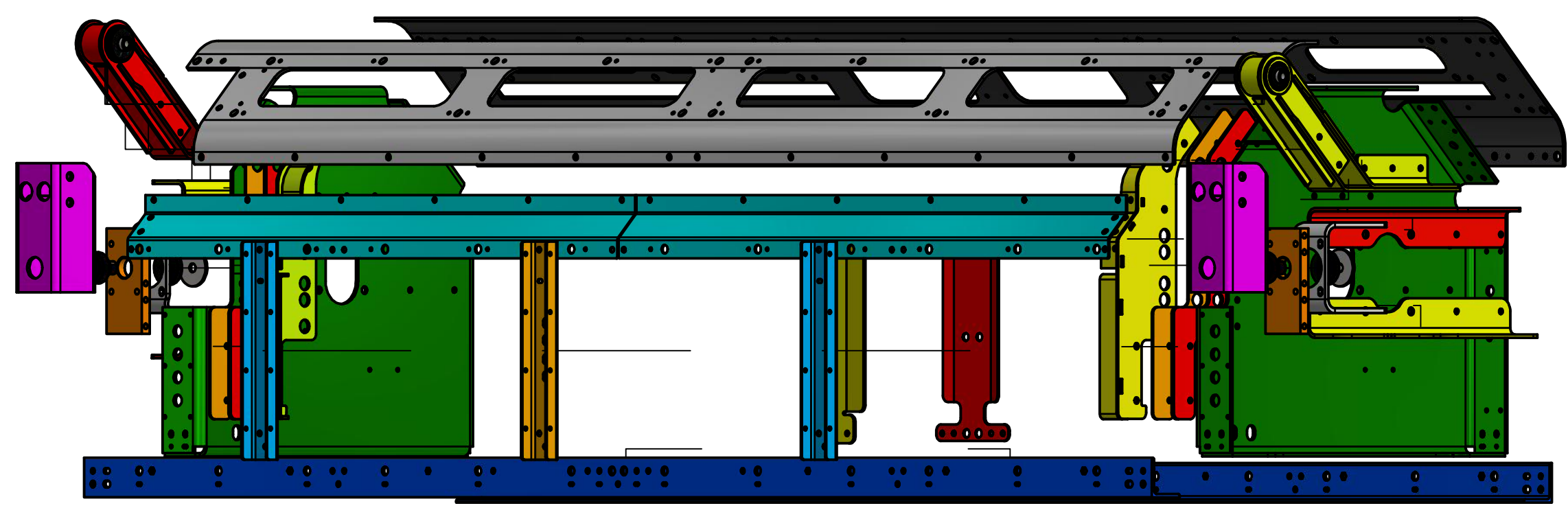

BACK

STRUCTURE

DRAWN	8/26/2017	MOMENTUM FUEL TECHNOLOGIES 1051 Republic Drive, Suite 200 Roanoke, TX 76262	
CHECKED	6/8/2018	TITLE	
CBC		60 DGE SIDE MOUNT - PARTS	
QA		SIZE	DWG NO
MFG		D	602-000060-STEPS-PARTS
APPROVED		SCALE	REV
PART MASS			
N/A			
		SHEET 2 OF 7	

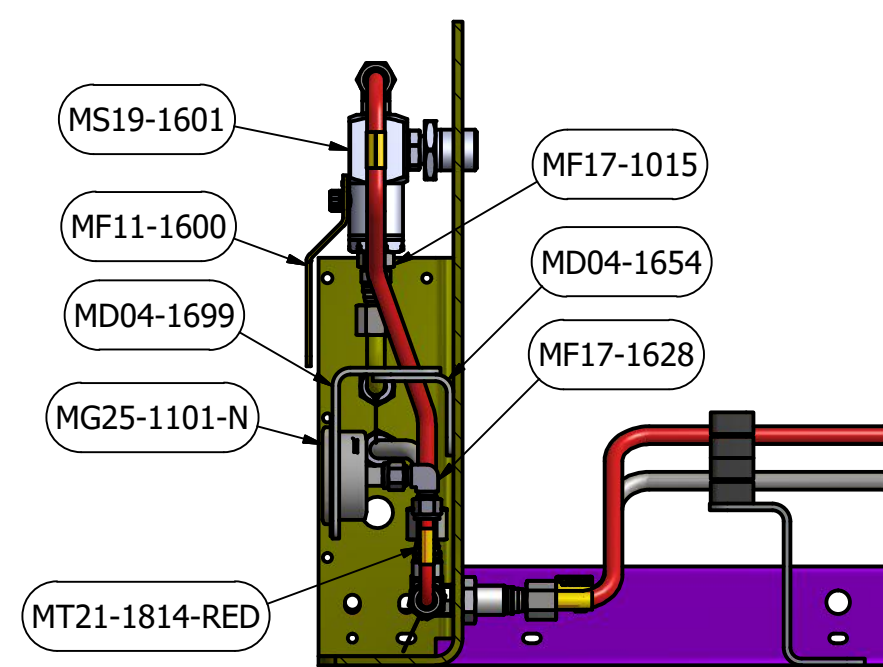
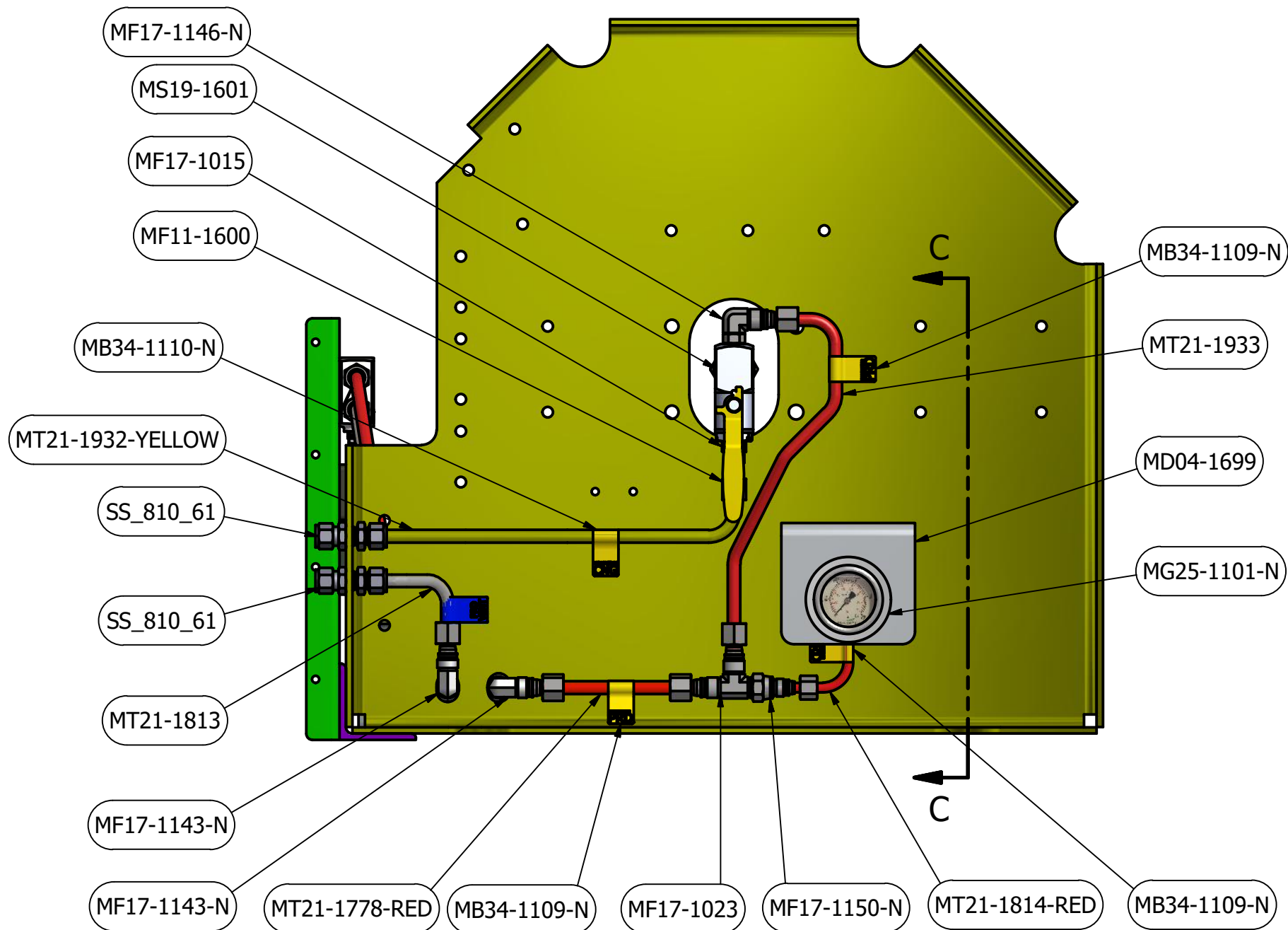
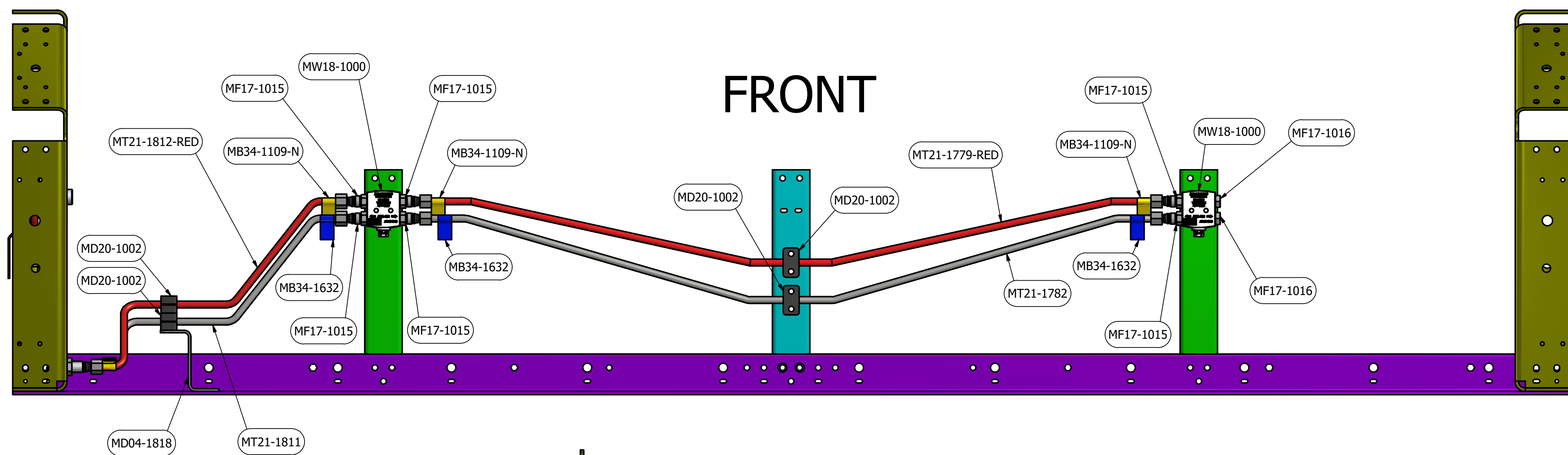
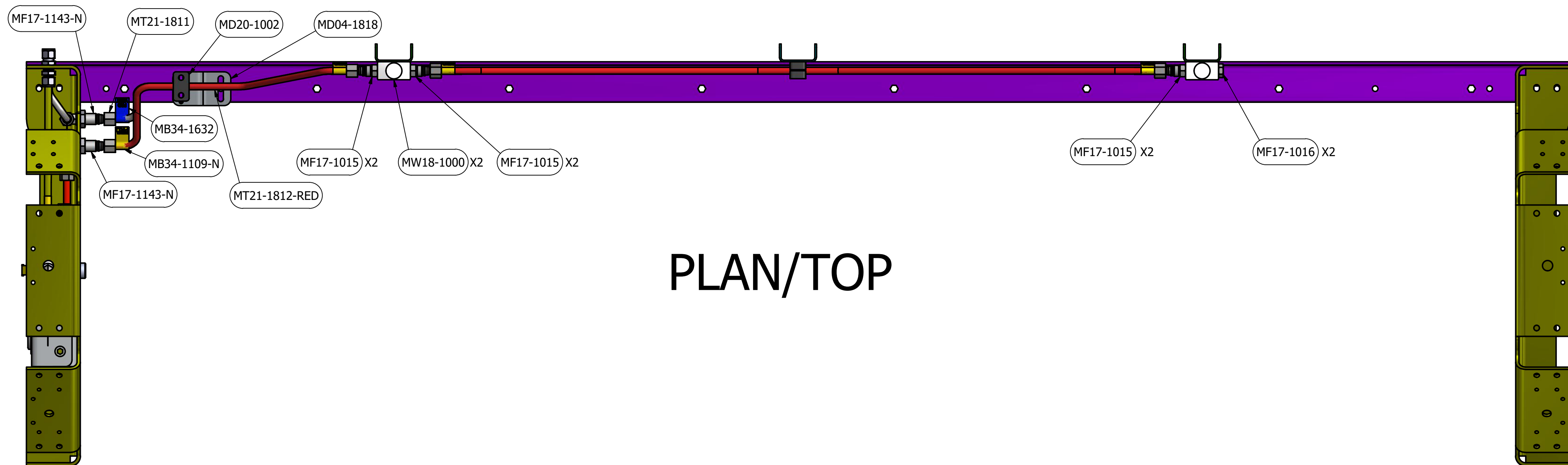

PLUMBING

DRAWN	LAR	8/26/2017	MOMENTUM FUEL TECHNOLOGIES 1051 Republic Drive, Suite 200 Roanoke, TX 76262	
CHECKED	CBC	6/8/2018	TITLE	
QA			60 DGE SIDE MOUNT - PARTS	
MFG			SIZE	DWG NO
APPROVED			D	602-000060-STEPS-PARTS
PART MASS	N/A		SCALE	REV
				SHEET 3 OF 7

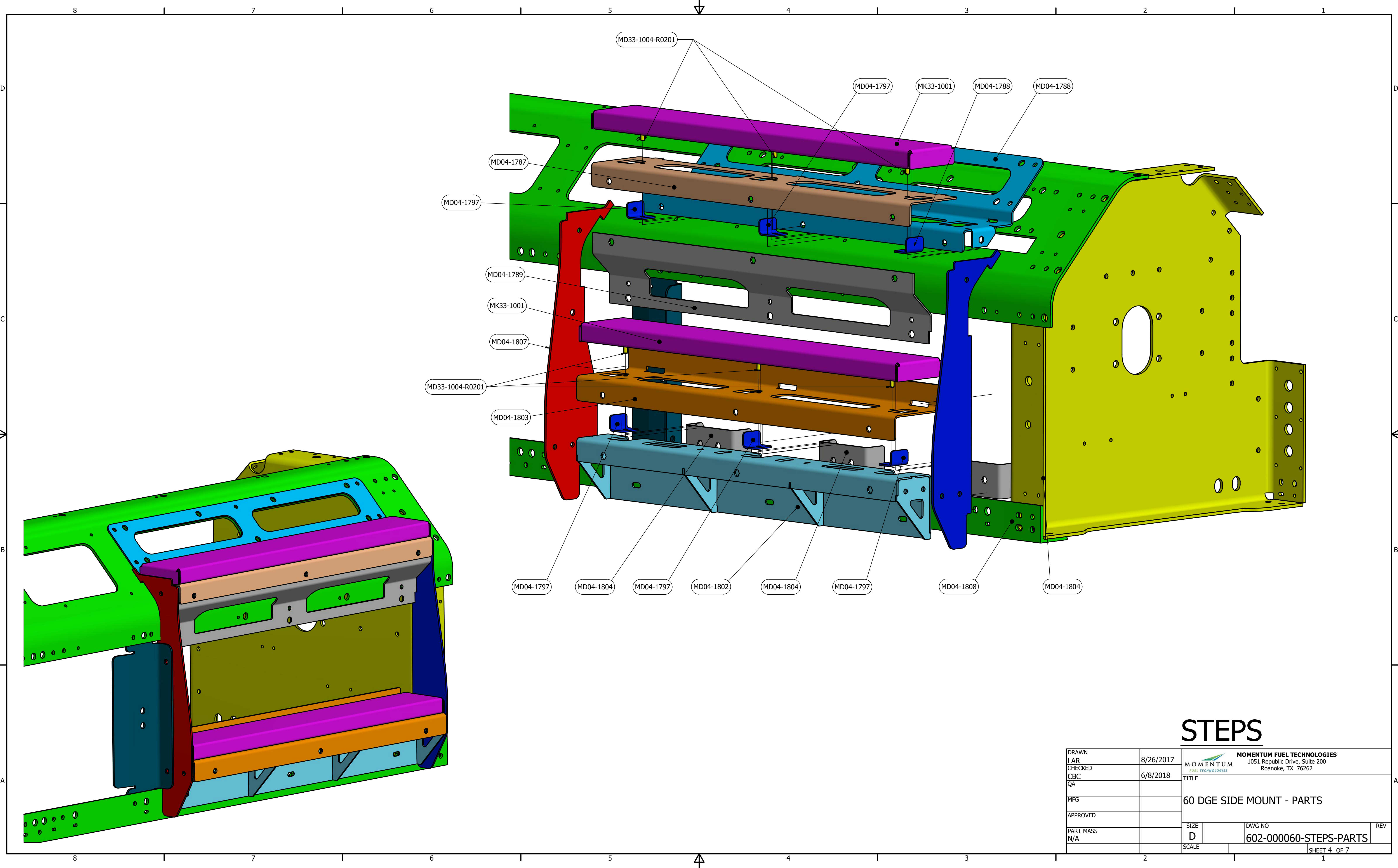

- MD33-1004-R0201
- MD04-1797
- MK33-1001
- MD04-1788
- MD04-1788
- MD04-1787
- MD04-1797
- MD04-1789
- MK33-1001
- MD04-1807
- MD33-1004-R0201
- MD04-1803
- MD04-1797
- MD04-1804
- MD04-1797
- MD04-1802
- MD04-1804
- MD04-1797
- MD04-1808
- MD04-1804

STEPS

DRAWN	LAR	8/26/2017	 MOMENTUM FUEL TECHNOLOGIES 1051 Republic Drive, Suite 200 Roanoke, TX 76262	
CHECKED	CBC	6/8/2018	TITLE	
QA			60 DGE SIDE MOUNT - PARTS	
MFG			SIZE	D
APPROVED			DWG NO	602-000060-STEPS-PARTS
PART MASS	N/A		SCALE	1
				REV
				SHEET 4 OF 7

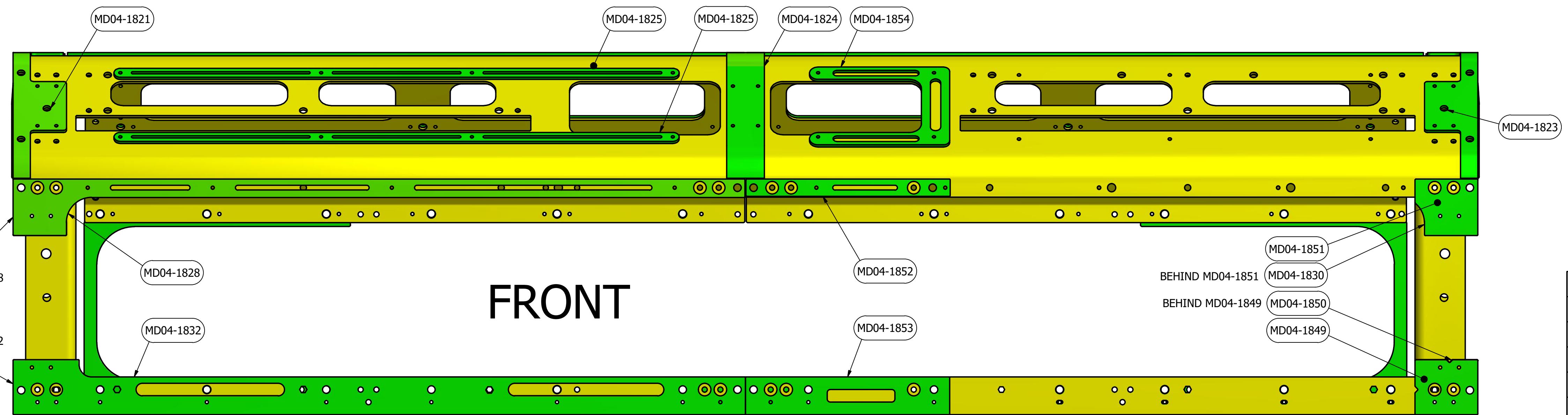
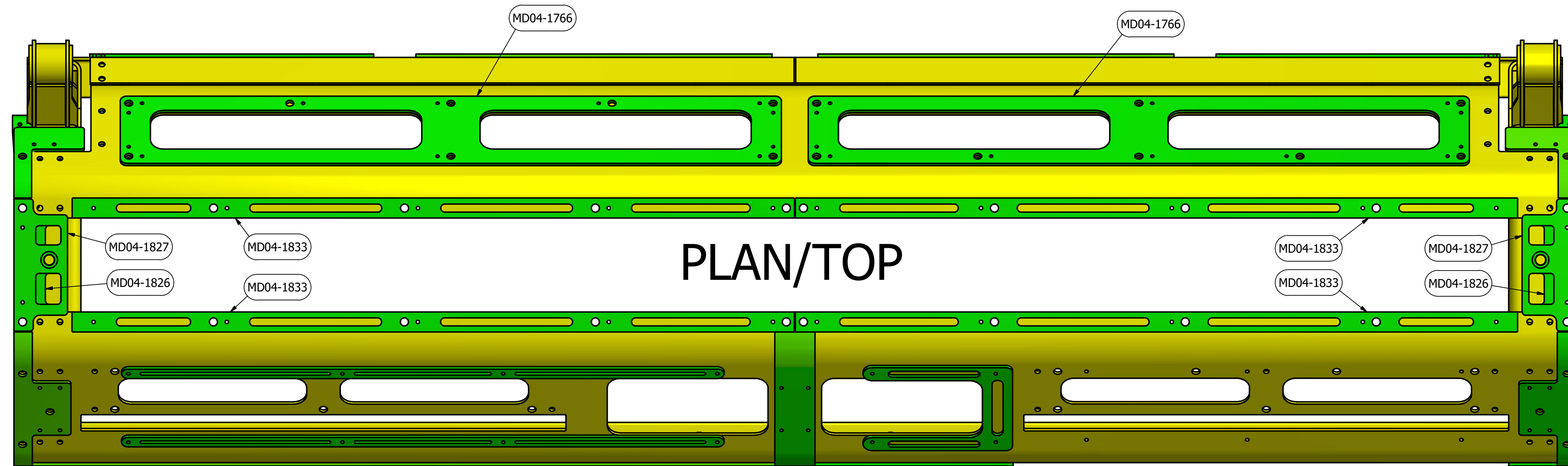
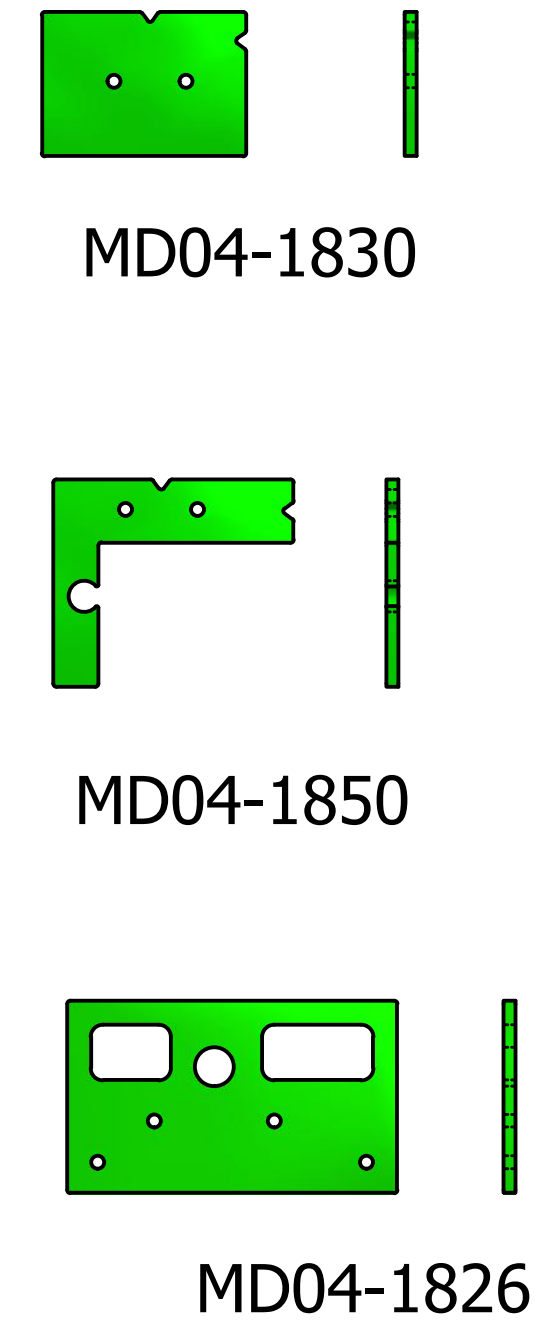
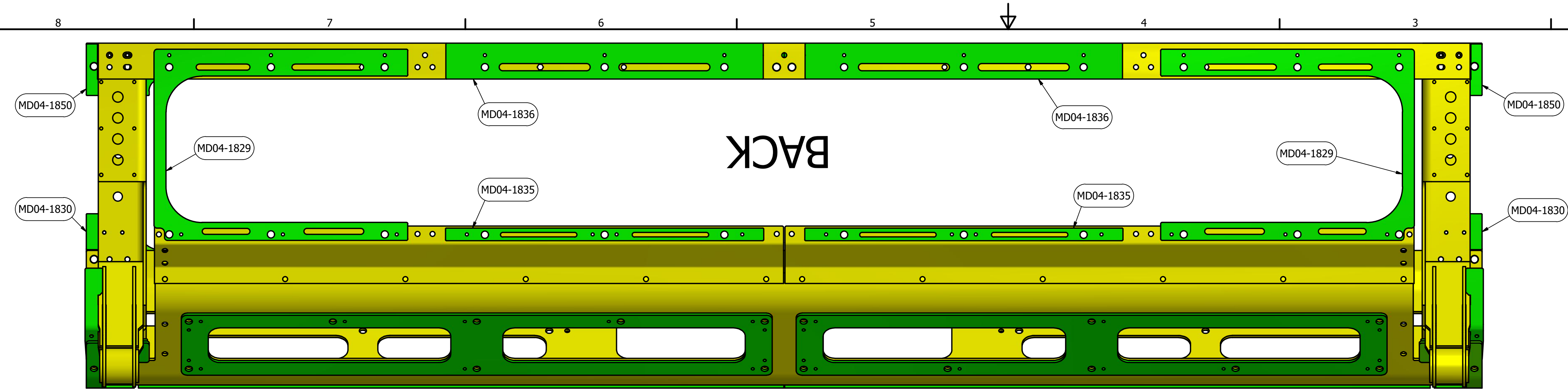

SPACERS FOR COVERS

DRAWN	8/26/2017	MOMENTUM FUEL TECHNOLOGIES 1051 Republic Drive, Suite 200 Roanoke, TX 76262	
LAR		TITLE	
CHECKED	6/8/2018	60 DGE SIDE MOUNT - PARTS	
CBC		SIZE	DWG NO
QA		D	602-000060-STEPS-PARTS
MFG		SCALE	REV
APPROVED			
PART MASS			
N/A			

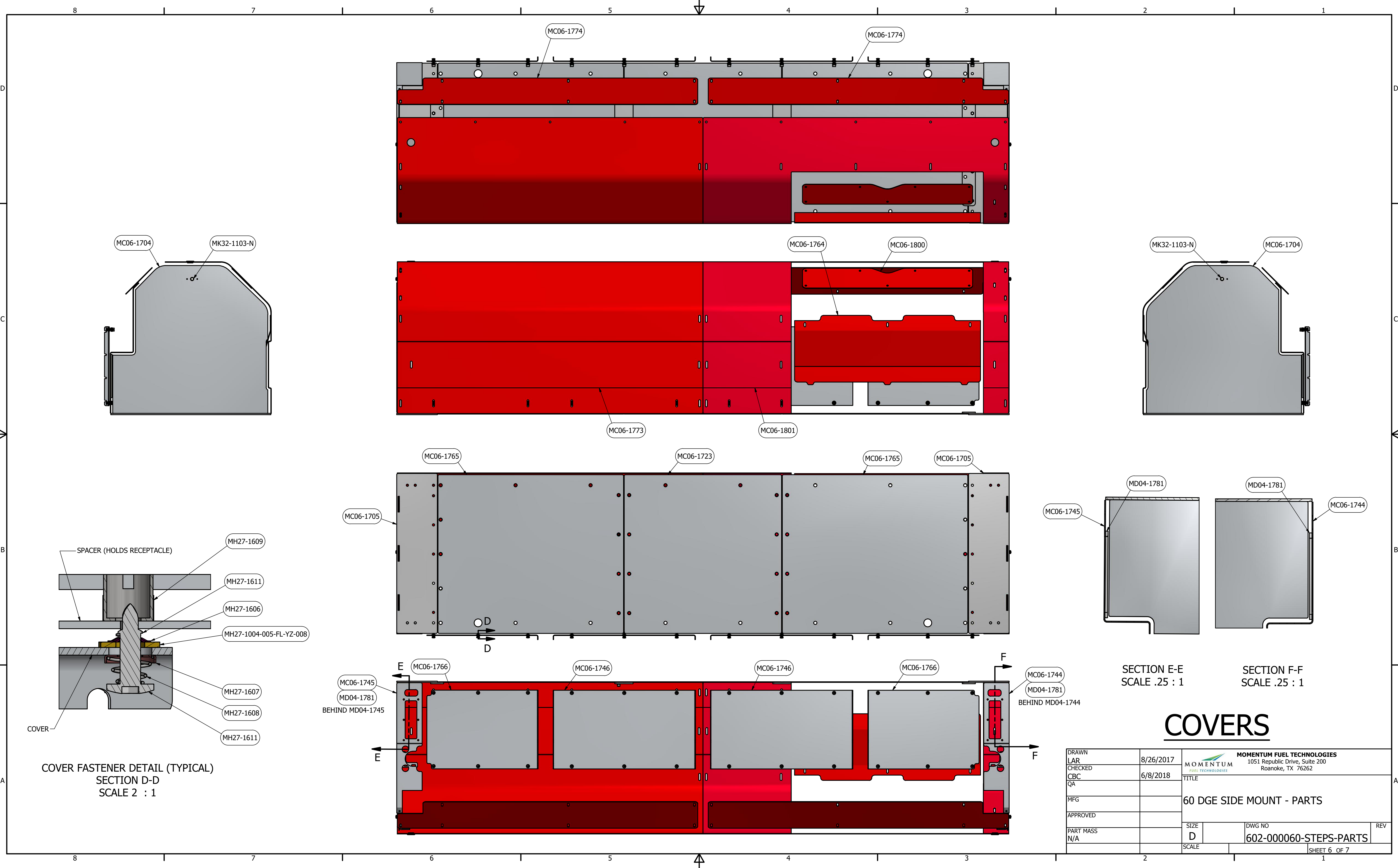

COVER FASTENER DETAIL (TYPICAL)
SECTION D-D
SCALE 2 : 1

SECTION E-E
SCALE .25 : 1

SECTION F-F
SCALE .25 : 1

COVERS

DRAWN	LAR	8/26/2017	MOMENTUM FUEL TECHNOLOGIES 1051 Republic Drive, Suite 200 Roanoke, TX 76262	
CHECKED	CBC	6/8/2018	TITLE	
QA			60 DGE SIDE MOUNT - PARTS	
MFG			SIZE	DWG NO
APPROVED			D	602-000060-STEPS-PARTS
PART MASS	N/A		SCALE	REV

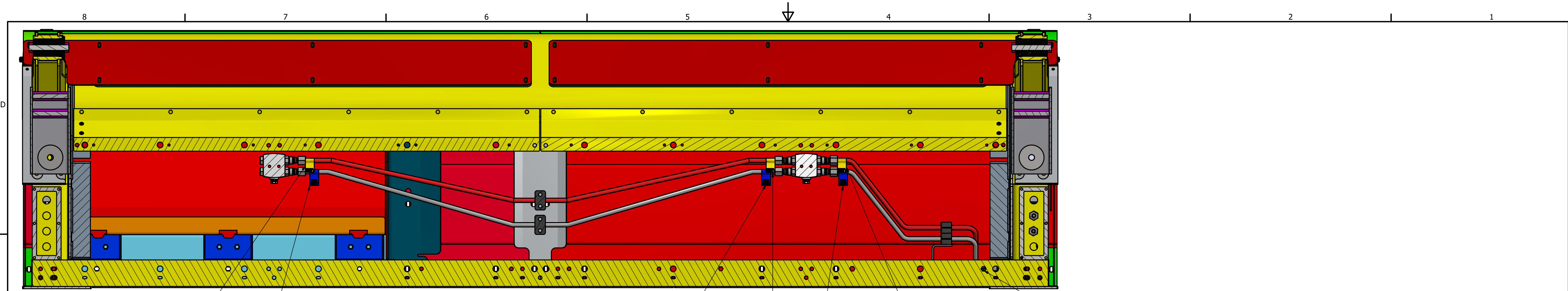

SECTION R-R
SCALE .1875 : 1

MB34-1109-N MB34-1632 MB34-1632 MB34-1109-N MB34-1632 MB34-1109-N MB34-1632 MB34-1109-N

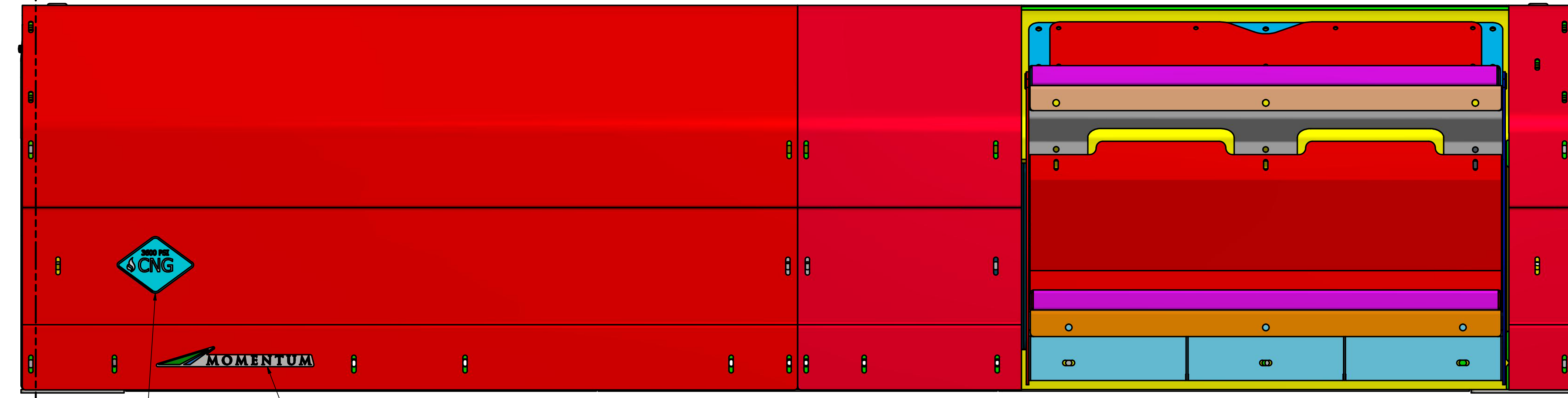

SECTION H-H
SCALE .1875 : 1

MB34-1100-N MB34-1001 MB34-1003 MB34-1015 MB34-1007 MB34-1109-N MB34-1614

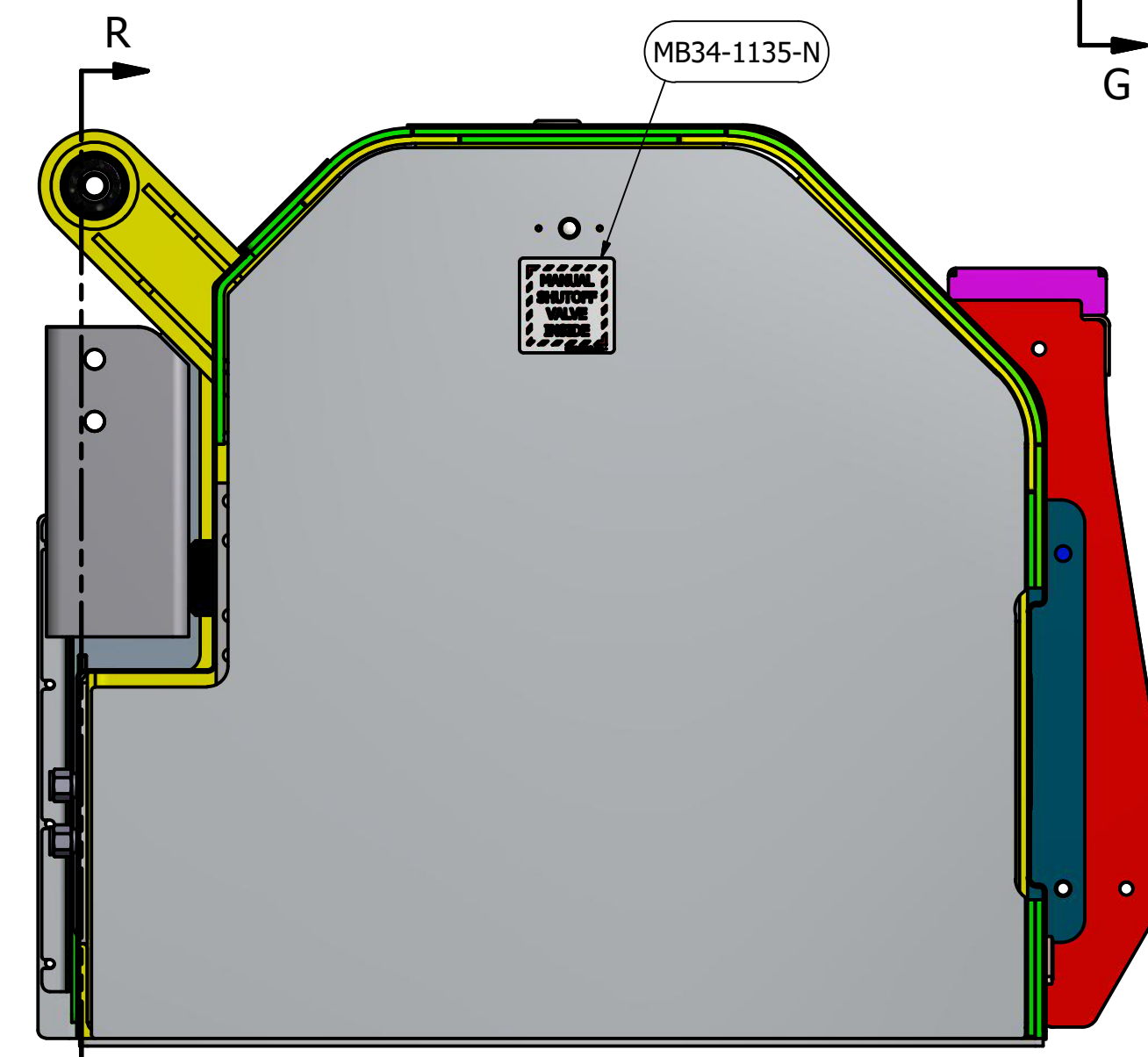

VIEW G-G
SCALE .1875 : 1

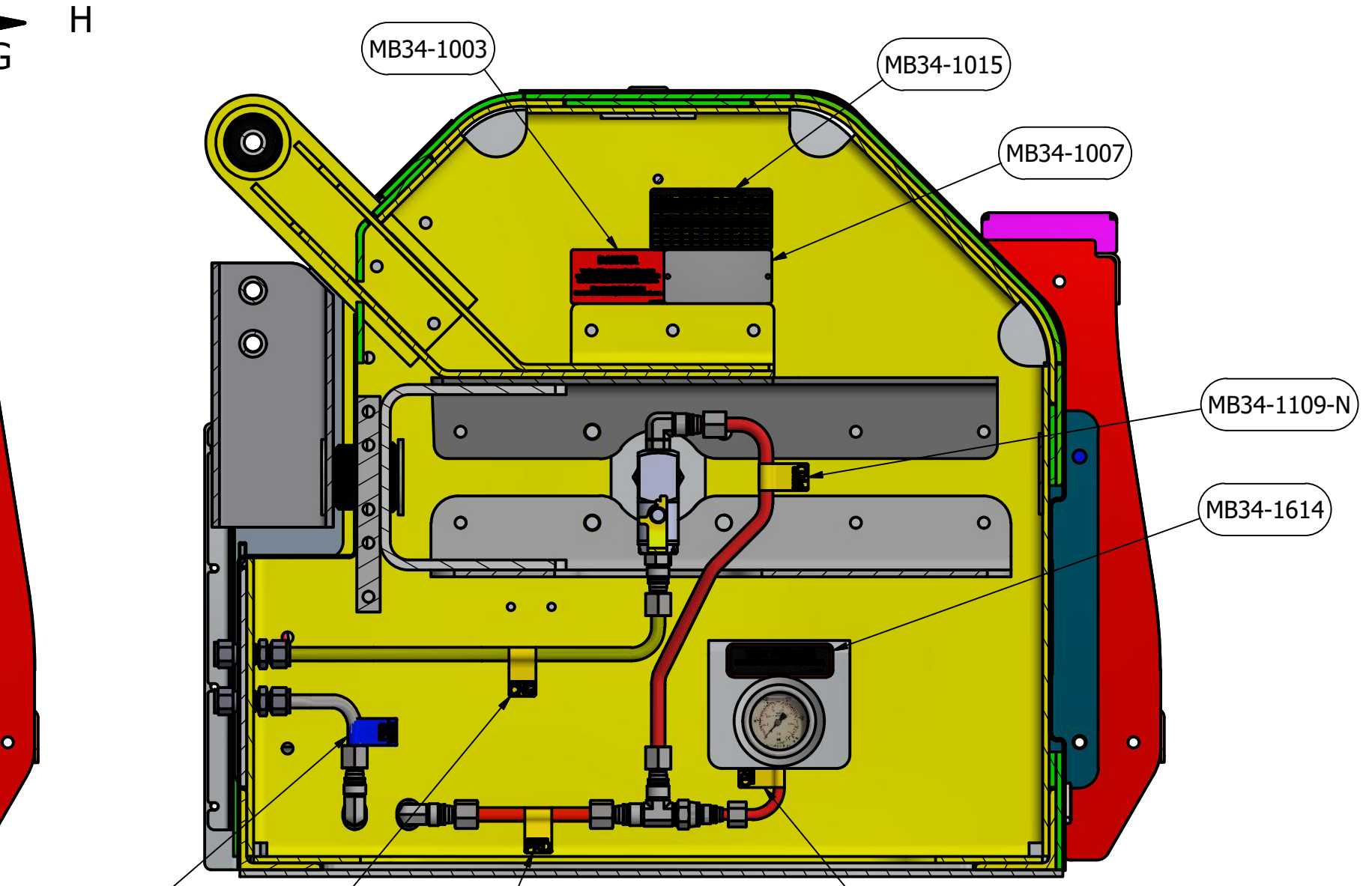

SECTION H-H
SCALE .1875 : 1

MB34-1632 MB34-1110-N MB34-1109-N MB34-1109-N

DECALS/BADGES

DRAWN	LAR	8/26/2017	 MOMENTUM FUEL TECHNOLOGIES 1051 Republic Drive, Suite 200 Roanoke, TX 76262	
CHECKED	CBC	6/8/2018	TITLE	
QA			60 DGE SIDE MOUNT - PARTS	
MFG			SIZE	DWG NO
APPROVED			D	602-000060-STEPS-PARTS
PART MASS	N/A		SCALE	REV
				SHEET 7 OF 7